

Direct Diode

Monocrom@PULS Direct Diode

Features:

- Passively cooled pulsed direct beam
- Clamping™ Patented Technology (Solder free mounting of laser bars)
- Long lifetime
- High reliability
- Low thermal resistances
- Wide storage temperature - 40° C to + 85° C
- No SMILE effect

Suitable for:

- Gated imaging
- Illumination
- LIDAR

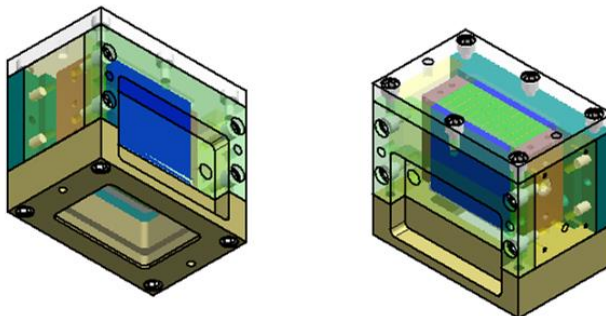
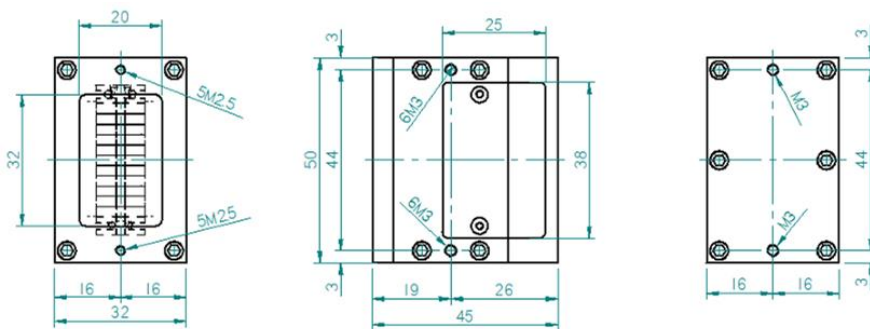

Monocrom@PULS Direct Diode

Product specification are subject to change without notice.
For complete details, please contact your local MONOCROM sales representative.

UNE EN ISO 9001:2015

MONOCROM S.L.

C/Vilanoveta 6
08800 Vilanova i la Geltrú (Barcelona)
Spain
T. +34 938 149 450
F. +34 938 143 767
E. sales@monocrom.com
www.monocrom.com

Laser parameters^(1,2,3)

Type	pulsed direct diode module		
Wavelength ⁽⁴⁾ [nm]	1550± 10		
Spectral width (FWHM) [nm]	< 15		
Number of laser bars	6	8	10
Peak power, QCW [W]	up to 270	up to 360	up to 450
Repetition rate [Hz]	up to 500		
Pulse length [ns]	50 – 150		
Rise-/fall-time ⁽⁵⁾ [ns]	15		
Max duty cycle [%]	0.01		

Electrical parameters

Driver electronics	included		
Operating current [A]	0.1		
Operating voltage [V]	12		
Charging voltage ⁽⁶⁾ [V]	up to 195		
Electrical connection	flying wires or solder tabs		
Trigger input	5 V TTL @ 50 Ω		
Trigger signal duration	same as pulse length desired		

Optical fiber⁽⁶⁾

Clear aperture [mm]	32 × 20		
Horizontal beam dimension ⁽⁷⁾ [mm]	11		
Vertical beam dimension ⁽⁷⁾ [mm]	12	16	21
Horizontal divergence ⁽⁸⁾ [°]	10		
Vertical divergence ⁽⁸⁾ [°]	30		
Optional optics available ⁽⁹⁾	FAC / BTS / SAC		
Laser bar smile [μm]	< 0.3		

Other parameters

Operating temperature [°C]	non-condensing to 55		
Storage temperature [°C]	between -10 and 60		
Integrated cooling	TEC		
Weight [g]	250		
Housing dimension (w × h × l) [mm]	32 × 50 × 45		
Lifetime [pulses]	2 × 10 ⁹		
Laser class product (EN-60825)	4		

1. Specifications at 20 °C, at the beginning of the lifetime.
2. If any other requirements are needed, please contact us.
3. QCW: with integrated driver electronics: Duty cycle below 0.01%.
4. Other wavelengths are also available.
5. Rise-/fall-times are determined via 20% to 80% and vice versa.
6. A second PSU is needed to set the injection current for the diodes. The following equation can be use: $U_{charge} = U_{LB} + 1.1 \times I_{inj}$.
7. Beam diameter is determined via $1/e^2$ value in the near field.
8. Divergence is determined via FWHM value.
9. Additional optics can have an impact on the package size.

Monocrom@PULS Direct Diode

Product specification are subject to change without notice.
For complete details, please contact your local MONOCROM sales representative.

MONOCROM S.L.

C/Vilanoveta 6
08800 Vilanova i la Geltrú (Barcelona)
Spain
T. +34 938 149 450
F. +34 938 143 767
E. sales@monocrom.com
www.monocrom.com