

# Actively Cooled Laser Bar Mount

AS-Mount  $\lambda$ 870-890 nm

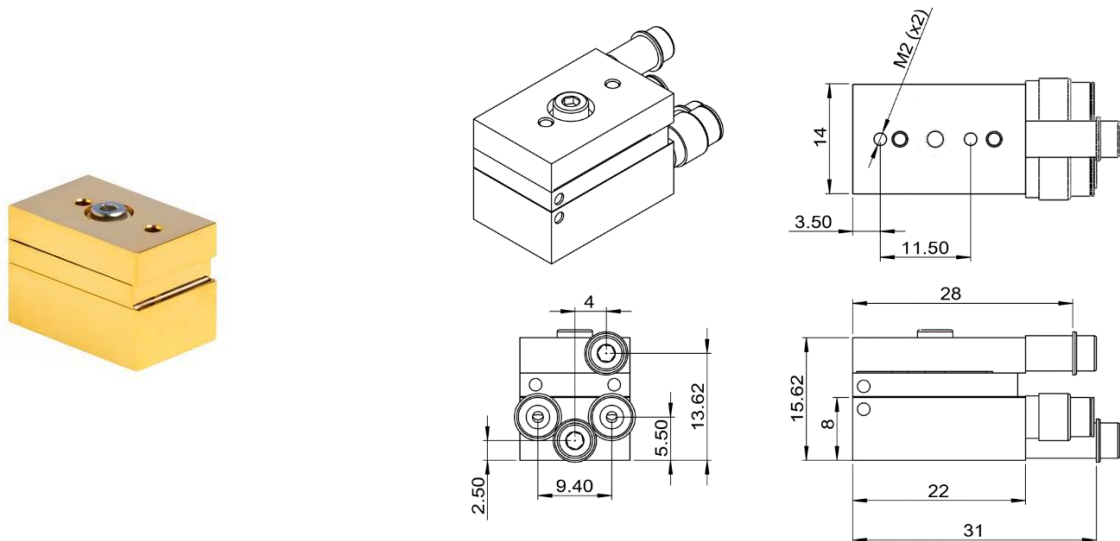

## Features:

Improved cooling efficiency  
 No “smile” effect  
 Number of bars on demand  
 Central wavelength on demand  
 Real macro-channels cooling

## Suitable for:

Surgical cardiology  
 Ophthalmology  
 Odontology  
 Hair removal  
 Interstitial laser induced thermotherapy  
 Material processing  
 Printing

Technical specifications <sup>(1,2)</sup>	
Wavelength <sup>(3)</sup> [nm]	870 - 890
Wavelength tolerance [nm]	±5
Spectral width, FWHM [nm]	< 5
Wavelength shift [nm/K]	0.33
Output power <sup>(2,4)</sup> [W]	CW - up to 100 / QCW - up to 500
Operating current [A]	CW < 120 / QCW < 480
Differential slope, after threshold [W/A]	1.2
Voltage @ connectors <sup>(5)</sup> [V]	2
Optics (optional)	FAC / SAC / BT
Smile [μm]	< 0.1

1. Specifications at 20 °C, at the beginning of the lifetime
2. Specifications are subject to chips availability
3. Other wavelengths on request
4. Expected output power per laser bar can varies based on current and temperature
5. Voltage from the power supply must be higher, as due to high current there will be a voltage drop in the cables