

Conduction Cooled Laser Bar Stack M-Stack λ 960-980 nm

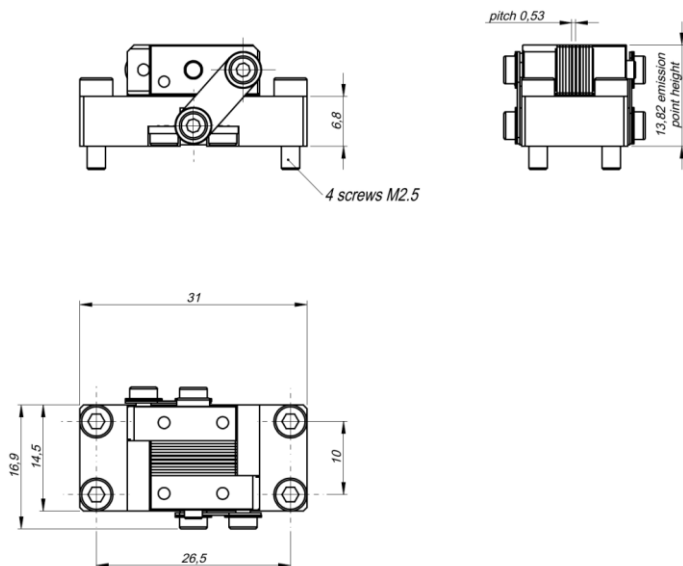

Features:

Improved cooling efficiency
 No “smile” effect
 No mechanical stress
 Number of bars on demand
 Central wavelength on demand

Suitable for:

Hair removal
 Defense applications
 Material processing
 Industrial applications
 Printing

Technical specifications ^(1,2)	
Wavelength ⁽³⁾ [nm]	960 - 980
Wavelength tolerance [nm]	±5
Spectral width, FWHM [nm]	< 5
Wavelength shift [nm/K]	0.38
Output power, QCW ^(2,4) [W]	up to 400 / laser bar
Operating current [A]	< 380
Differential slope, after threshold [W/A]	1.1
Voltage @ connectors ⁽⁵⁾ [V]	2 - 20
Bar to bar pitch [mm]	down to 0.4
Optics (optional)	FAC / SAC / BT
Bars per stack ⁽⁶⁾	1 - 10
Smile [μm]	< 0.1

1. Specifications at 20 °C, at the beginning of the lifetime
2. Specifications are subject to chips availability
3. Other wavelengths on request
4. Expected output power can varies based on current and temperature
5. Voltage from the power supply must be higher, as due to high current there will be a voltage drop in the cables
6. Pitch dependent

M-STACK / 960 - 980 nm
 Version: 1.0.0.0 October 2021
 Product specification are subject to change without notice.
 For complete details, please contact your local MONOCROM sales representative.

MONOCROM S.L.
 C/Vilanoveta 6
 08800 Vilanova i la Geltrú
 Spain

T. +34 938 149 450
 E. sales@monocrom.com
www.monocrom.com

UNE EN ISO 9001:2015